

DISPENSA TANDEM side

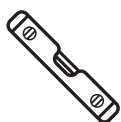

KESSEBÖHMER

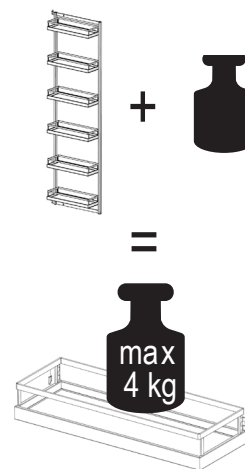
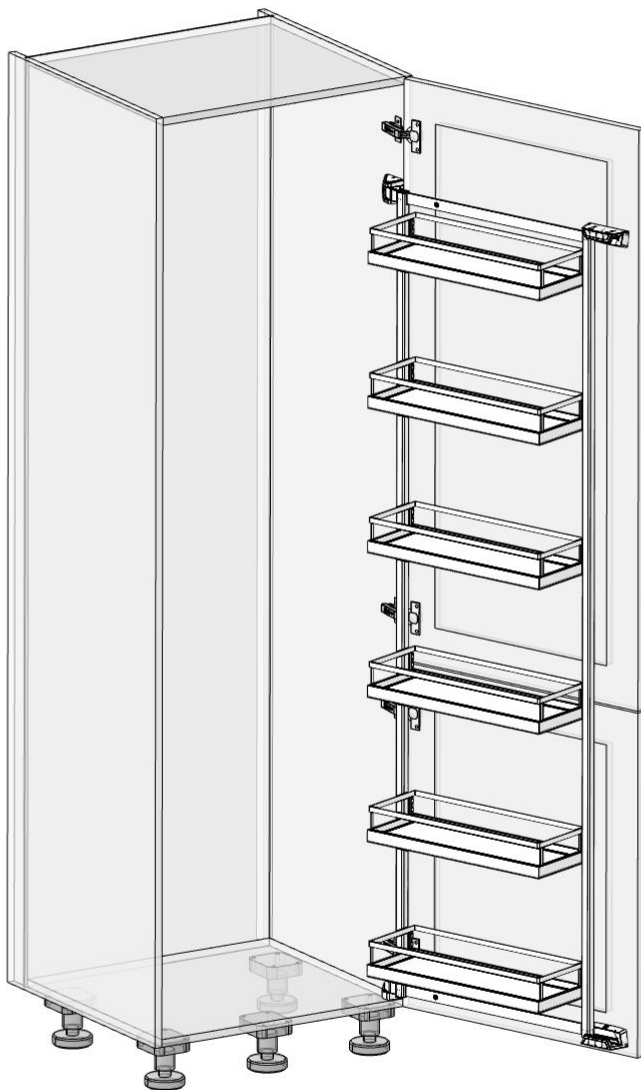

<http://support.kesseboehmer.de>



DISPENSA TANDEM side

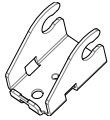
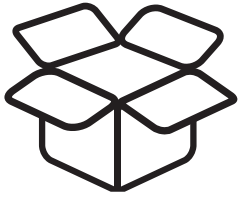

1x

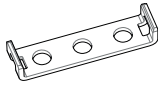

1x

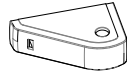

1x

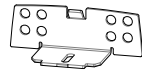

1x

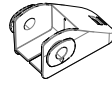

1x



1x

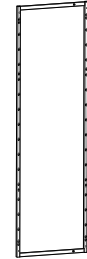

1x



6x

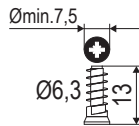
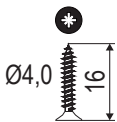

DE Die technischen Darstellungen und Maßangaben – auch bei Abbildungen und Zeichnungen – sind unverbindlich. Konstruktionsverbesserungen sind vorbehalten! **EN** Technical information and stated dimensions (including in illustrations and drawings) must not be regarded as binding. Design subject to improvement without notice! **FR** Les visuels techniques et dimensions – y compris les schémas et les illustrations – ne sont pas contractuelles. Sous réserve d'évolutions techniques! **IT** Le rappresentazioni tecniche e le indicazioni delle dimensioni – anche nelle figure e nei disegni – non sono vincolanti. Con riserva di miglioramenti di progettazione! **ES** Las imágenes técnicas y las indicaciones de medidas – también en imágenes y dibujos – no son vinculantes. Queda reservado el derecho de realizar mejoras en el diseño! **PT** Representações técnicas e dimensões – mesmo em ilustrações e desenhos – não são vinculativas. Reservado o direito a melhorias construtivas! **HE** סבייחמ יתלב סנה - תוינכתו סירויא יבגל הָא - תודימהו סיינכטה סימישרתה לכ **FI** Tekniset piirroksat ja mitat – myös kuvissa ja piirroksissa olevat – ovat sitoumuksetta. Oikeus rakennetta parantaviin muutoksiin pidätetään! **DA** De tekniske illustrationer og målangivelser – også på illustrationer og tegninger – er ikke bindende. Forbehold for designforbedringer! **CS** Technické popisy a rozměry, jakož i obrázky a výkresy, jsou nezávazné. Vyhrazujeme si právo na změny konstrukce! **PL** Prezentacje techniczne i wymiary – także na ilustracjach i rysunkach – nie są wiążące. Udoskonalenia konstrukcyjne są zastrzeżone! **RU** Иллюстрации технических деталей и указанные размеры, в том числе на рисунках и чертежах, являются ориентировочными. Компания оставляет за собой право на усовершенствование конструкции! **TR** Teknik sunum ve ölçü bilgileri (resim ve çizimlerde de) yasal olarak bağlayıcı değildir. Yapısal geliştirmeler yarma hakkı saklıdır! **BG** Техническото представяне и размерите, включително при изображенията и чертежите, са необвързващи. Запазваме си правото на конструктивни подобрения! **HU** A műszaki ábrázolások és méretadatok – ábránál és rajzoknál sem – nem kötelező érvényűek. A konstrukciós javítások joga fenntartva! **SR** Tehničke ilustracije i dimenzije - uključujući ilustracije i crteže - nisu obavezujući. Dizajn poboljšanja su rezervisana! **EL** Τα τεχνικά σχήματα και οι διαστάσεις – ακόμα και σε απεικονίσεις και σχέδια – δεν είναι δεσμευτικά. Με την επιφύλαξη τεχνικών βελτιώσεων! **AR** ةي ل كيه تانيسحت ءارج! يف ظوفحم قحلا ةيمازل! تسي ل - تاموسرلاو ةيحيضوتلا موسرلا كلذ يف امب - ةينفلا داعبأل او ةيحيضوتلا موسرلا **JP** 力が生みにくさが高じれ **ZH** 技术说明和规格，包括插图和图纸均不具约束力。保留改进设计的权利!

DISPENSA TANDEM side



i

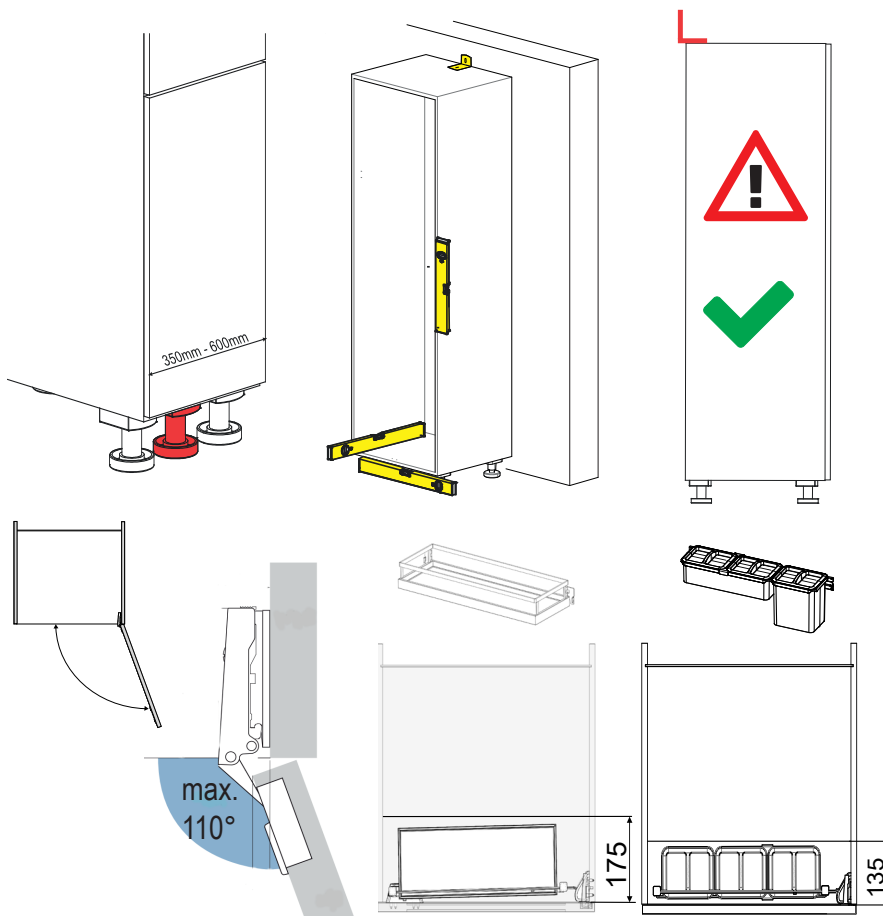

1

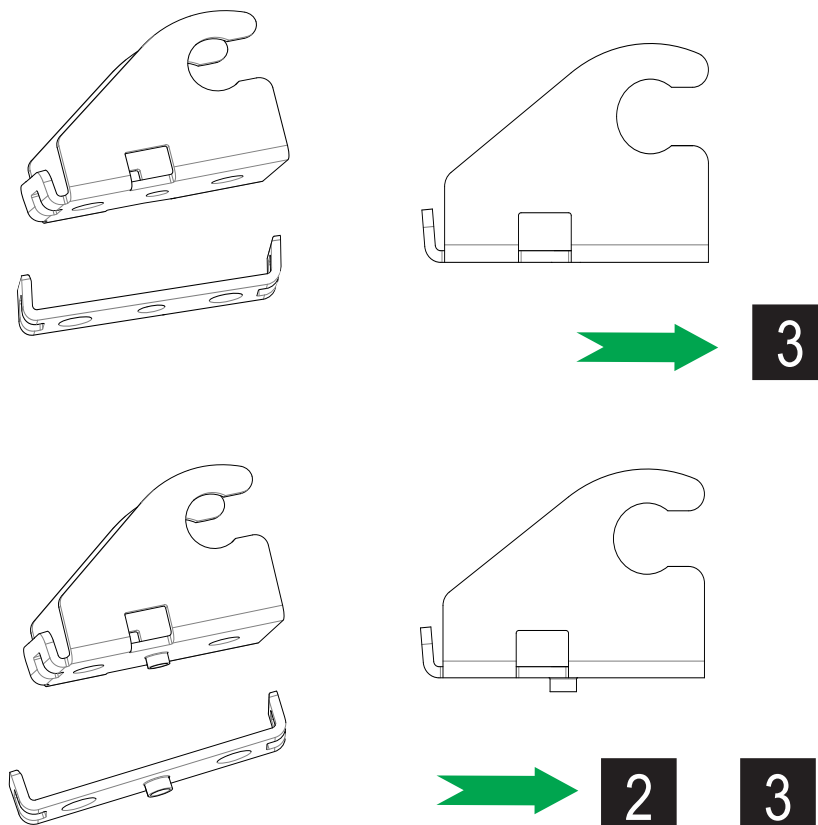

DISPENSA TANDEM side



2



5

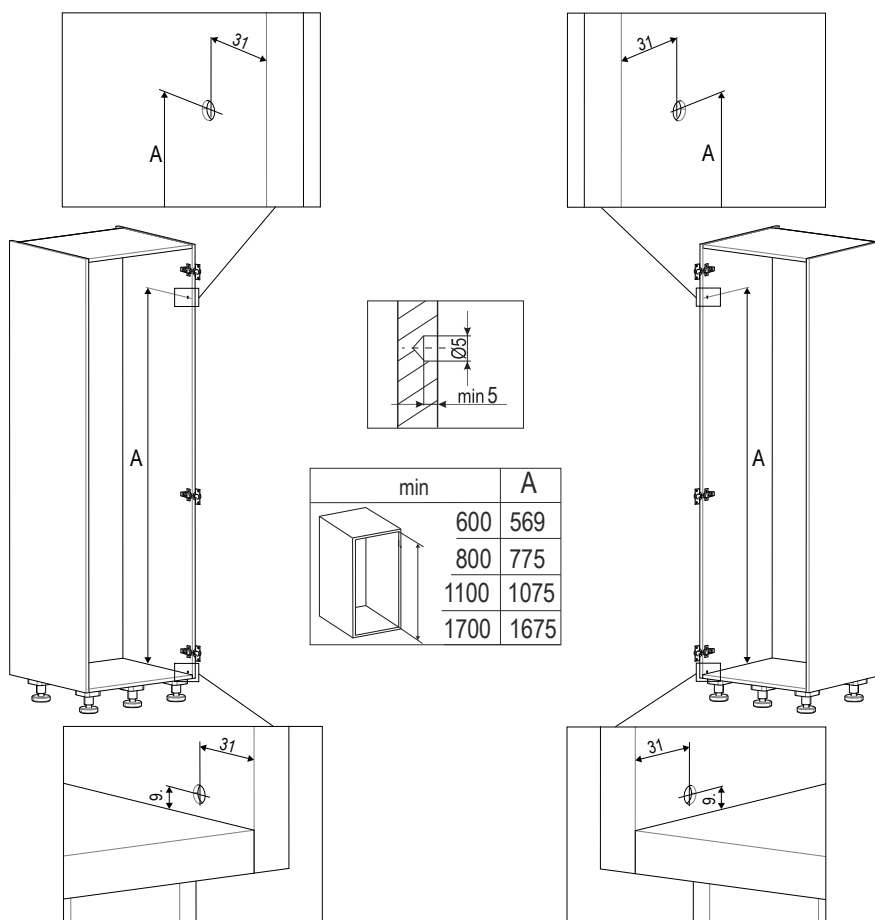

3

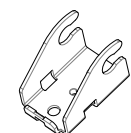

1x

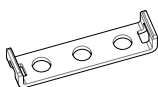

1x

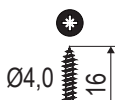

oder / or / ou

Ømin.7,5

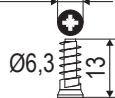

4x

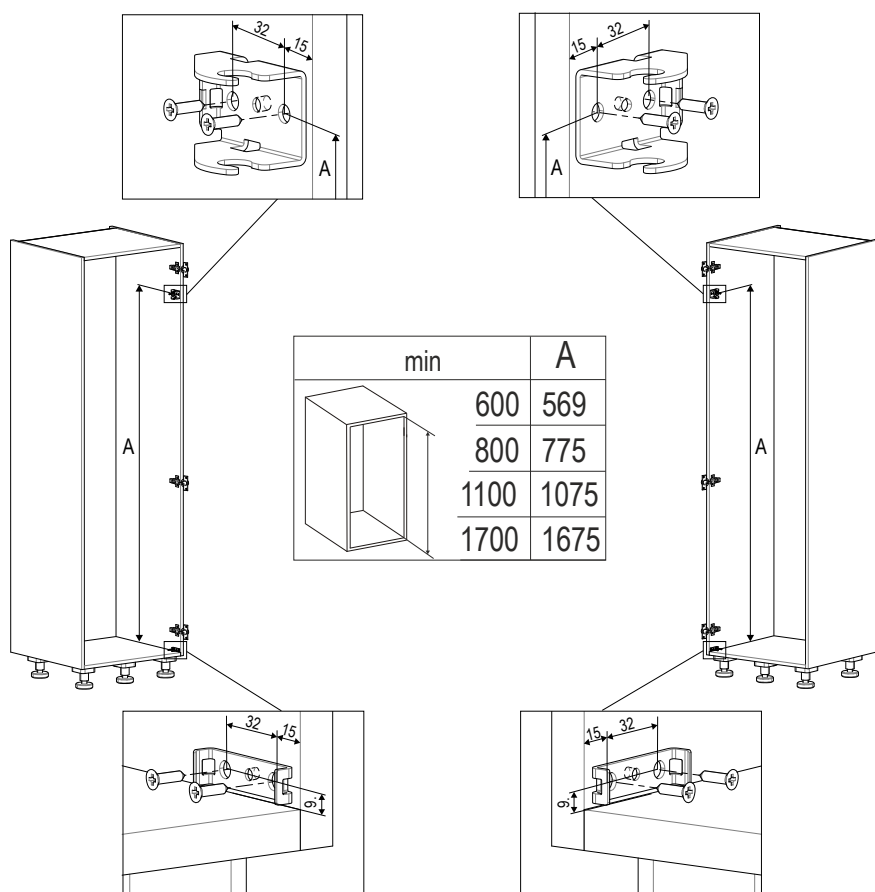

DISPENSA TANDEM side



5

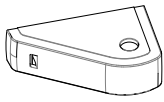

1x

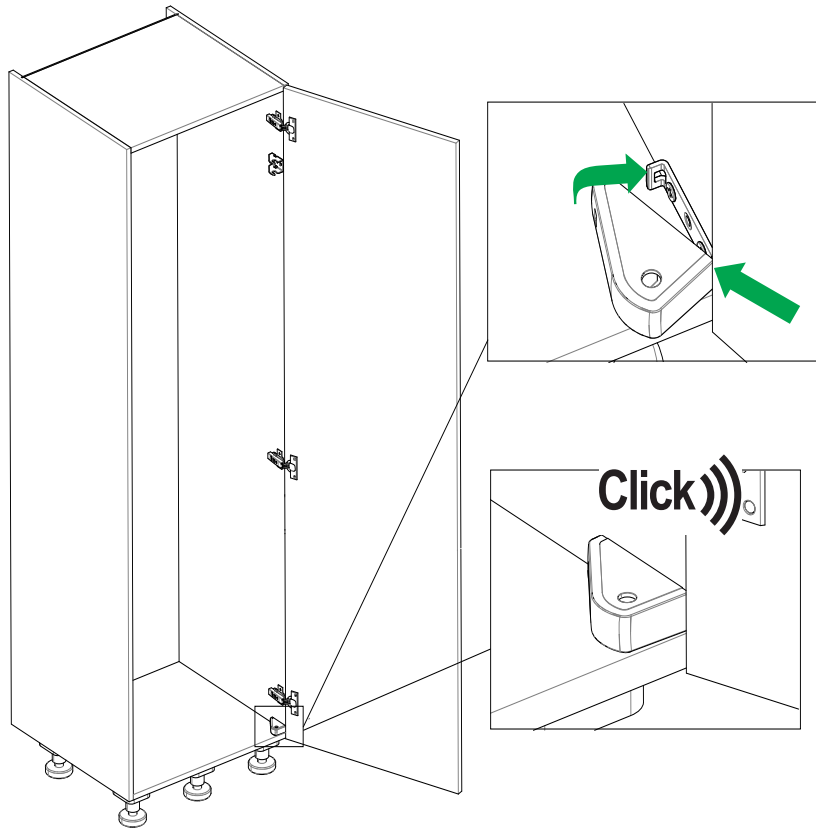

6

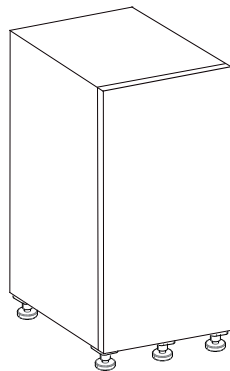

6a

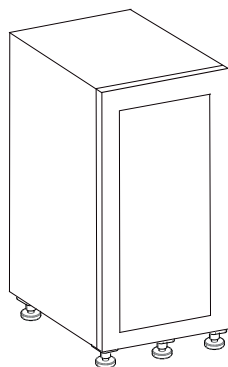

6b

DISPENSA TANDEM side



6a



1x

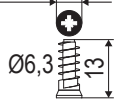
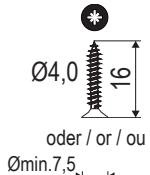

4x

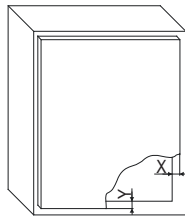
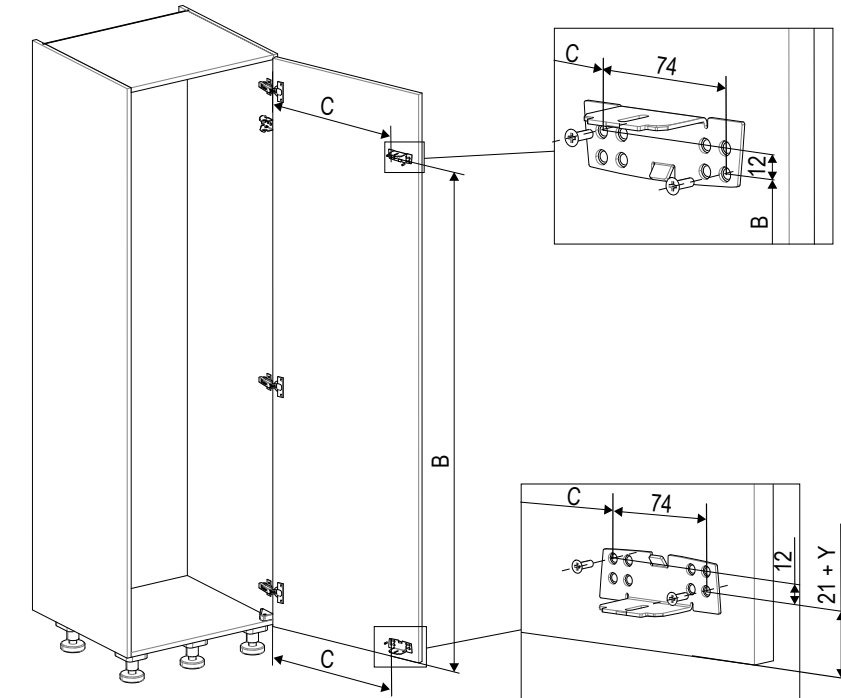

min	B
600	565+Y
800	771+Y
1100	1071+Y
1700	1671+Y

min	C
450	321+X
500	371+X
600	471+X

6b



1x

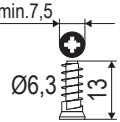
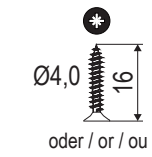

4x

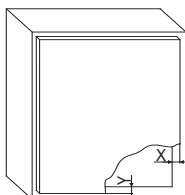
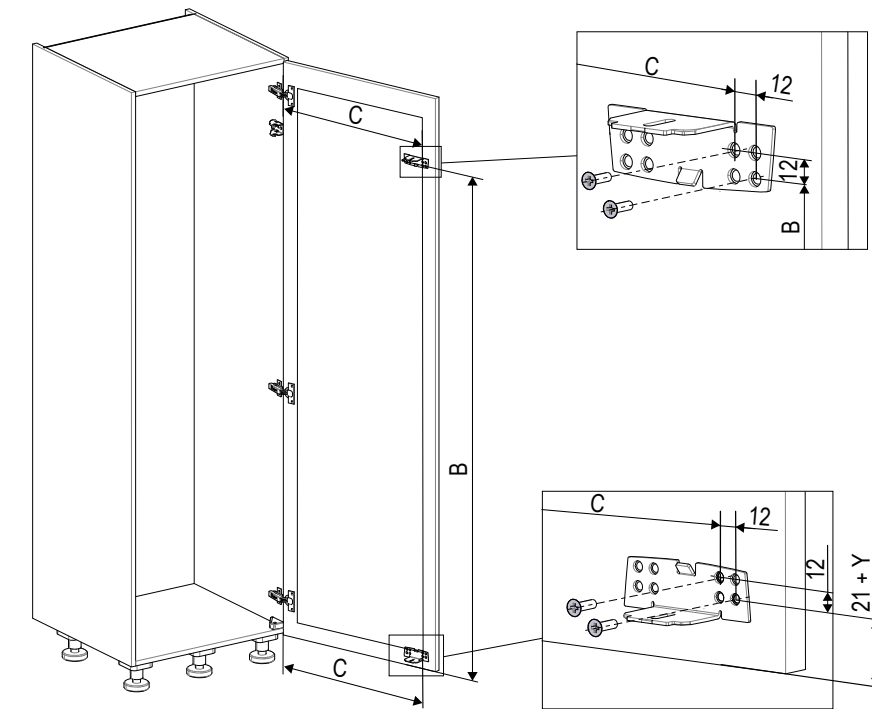

min	B
600	565+Y
800	771+Y
1100	1071+Y
1700	1671+Y

min	C
450	383+X
500	433+X
600	533+X

DISPENSA TANDEM side



7

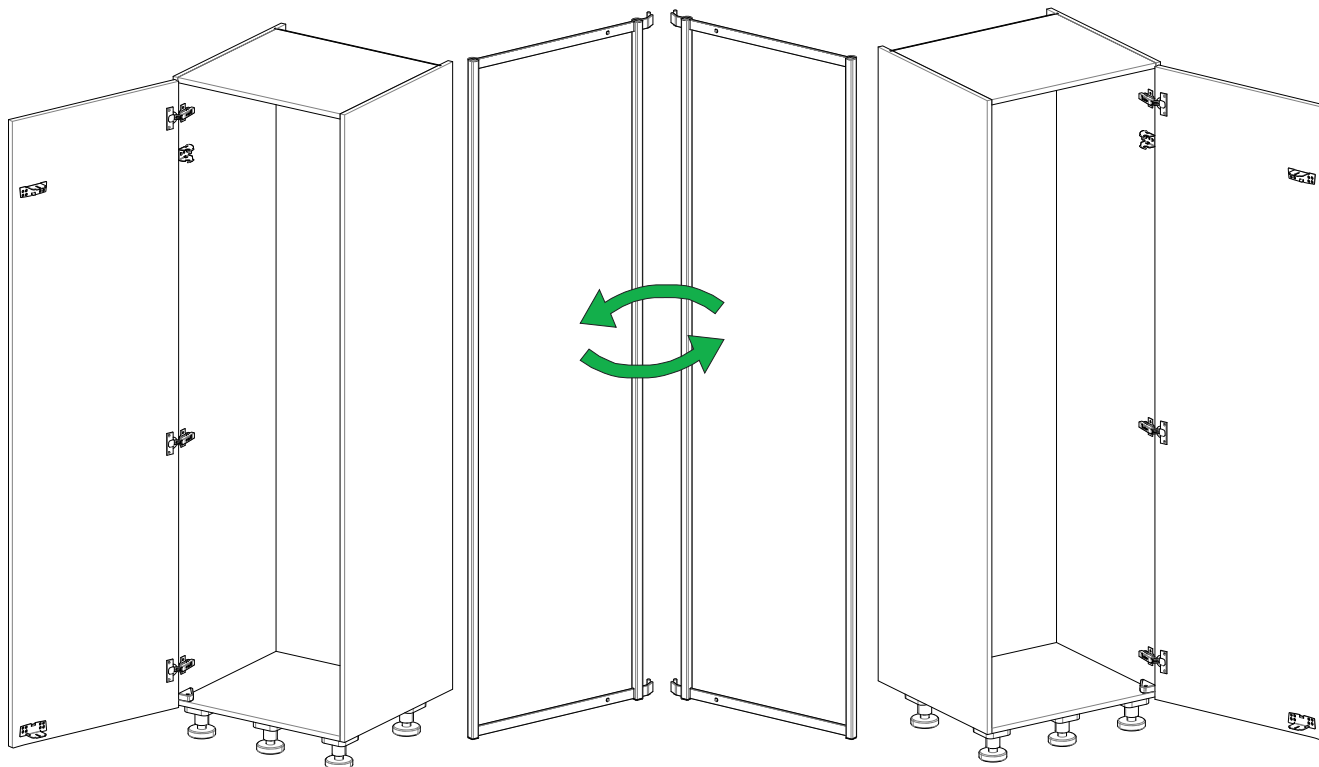

8

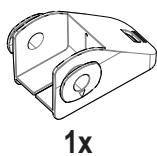

1x

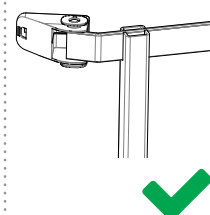
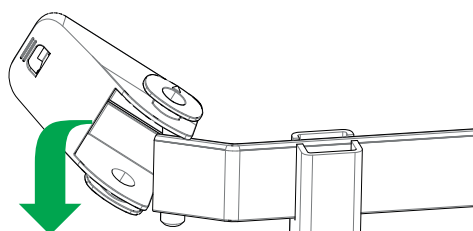
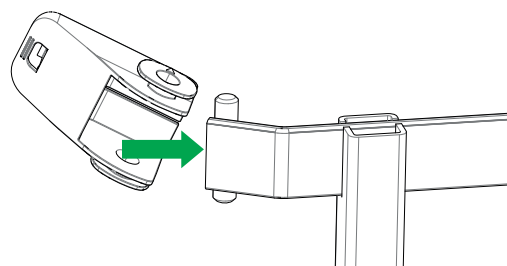
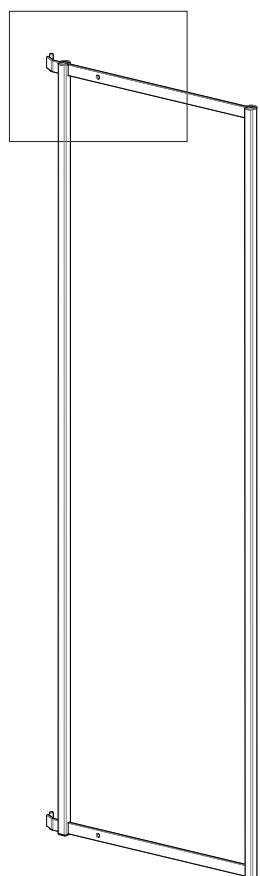

DISPENSA TANDEM side



9

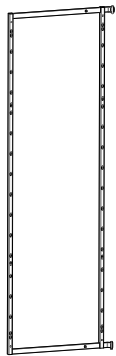

1x



1x

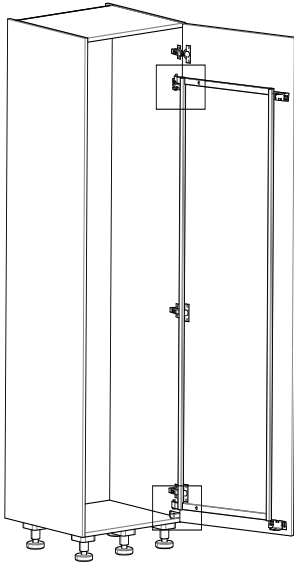

1.

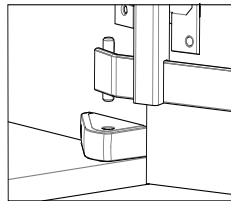

2.

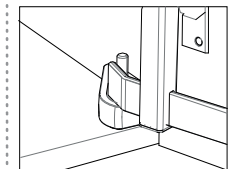
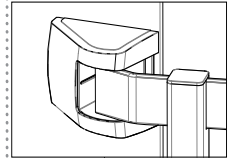
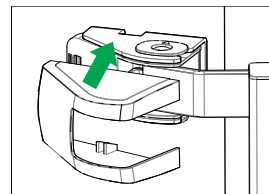
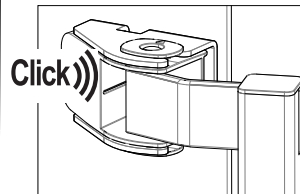
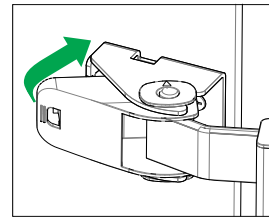
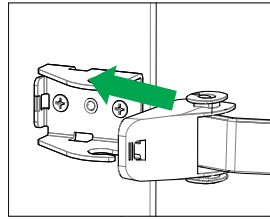

10

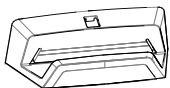

2x

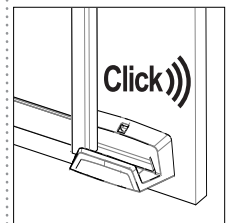
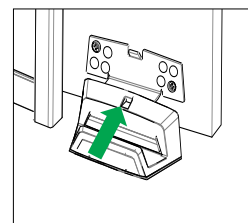
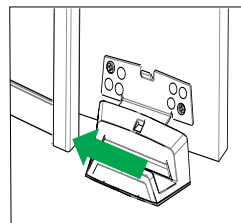
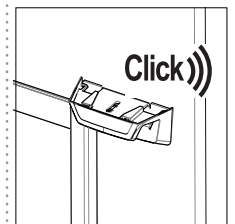
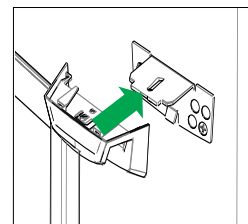
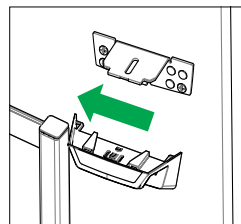
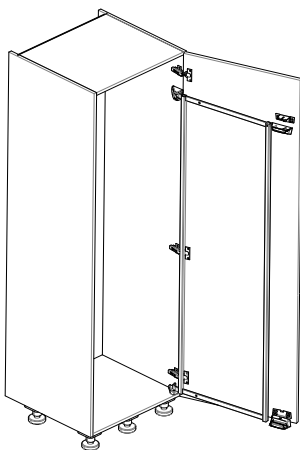

DISPENSA TANDEM side



11



2x

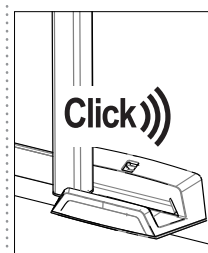
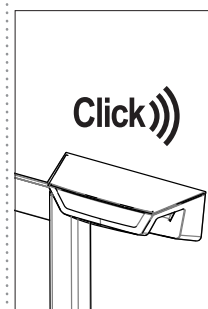
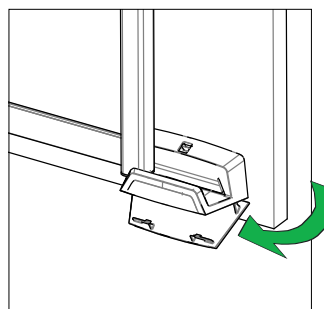
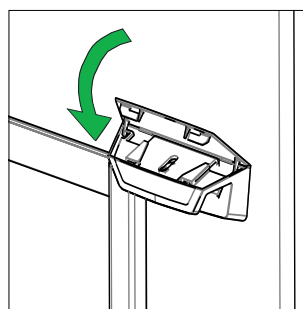
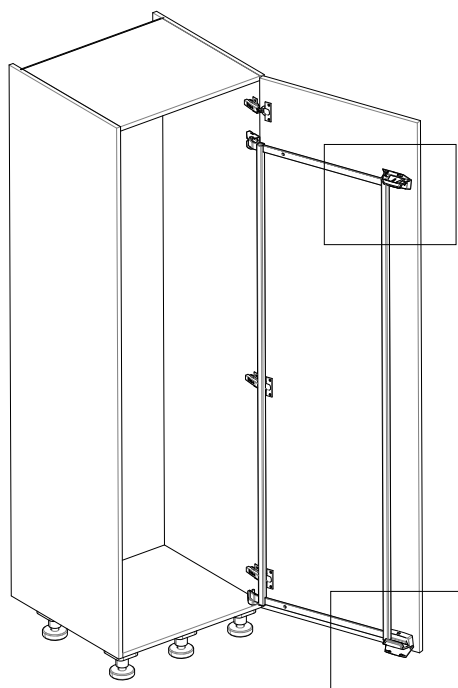

12



6x

